



# LABORATORY LINES

## ZOOM STEREO MICROSCOPE



**Kalstein**®

A different accompaniment, at your service

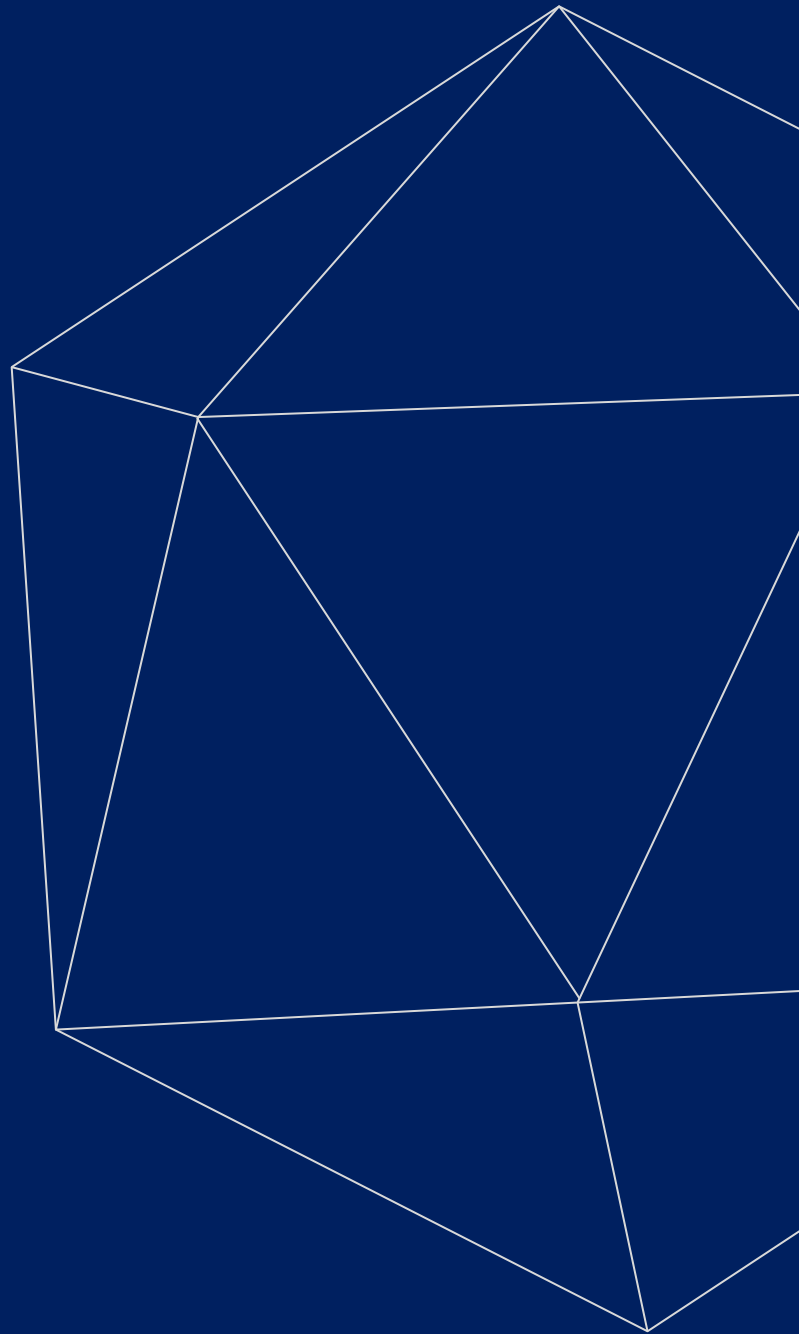



# Kalstein®

A different accompaniment, at your service

OUR SERVICES

## Benefits and Support

In Kalstein France, we take care of the full satisfaction of our customers, that is why we provide value-added services of the highest level based on our experience.



### Online Inductions and Trainings

In any part of the world, receive your induction or training from our specialized team of engineers



### Quick Response

Our work team is always available to response all your consults or questions, in order to support you in any situation.



### #Letsgivemore ♥

Thanks to your purchase, a donation will be made to a non-profit foundation that fights against breast cancer and helps most vulnerable communities.



### Technical Support

Enjoy of personalized advice for the correct preventive and corrective maintenance of your equipment, thanks to Kalstein's manuals and articles, special catalogues and video tutorials.



### Delivery Logistics

We take care of all the necessary logistics for the dispatch of your goods, whether is by sea, land or air.



### Kalstein Worldwide

With more than 25 years growing with our customers, Kalstein's multiformat and modern content, is now present in more than 10 countries and increasing.





## Zoom Stereo Microscope

Model YR0269

Kalstein's Zoom Stereo Microscope YR0269.

### Features:

- The leading roles of same level microscope, wide range observation with zoom range 0.6X-5X and visual field up to Ø76mm.
- With high quality optical components, providing sharp and striking contrast image and ensure flat image at large depth of field.
- Ease the tiredness with ergonomic design.
- With complete eyepieces, objectives, and accessories.



0.6X

2X

5X

## Wide Range Observation

- High magnification and large zoom ratio.
- Total magnification from 3X to 200X

## High Contrast

YR0269

Others

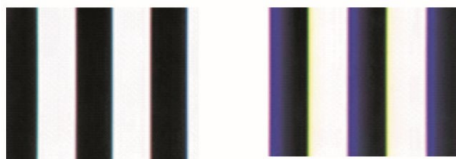

## High Resolution

YR0269

Others

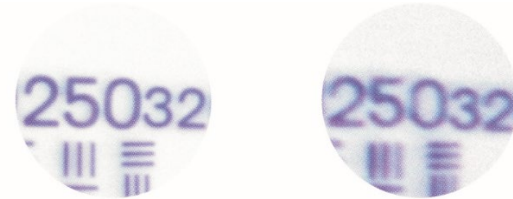

## Large Depth of Field

YR0269

Others

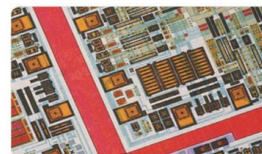

**It is an ideal instrument for** industry assembling, inspection and the teaching field.



#Letsgivemore

Thanks to your purchase, a donation will be made to a non-profit foundation that fights against breast cancer and helps most vulnerable communities.



All rights reserved © KALSTEIN France S. A. S.,  
Optimum Business Center 450 Rue Baden Powell,  
• 34000 Montpellier, France.  
Tél: +33 467158849 / +33 680760710 / +33 663810023  
<https://kalstein.eu>  
KALSTEIN FRANCE, S.A. S



## Dimension Drawing of Zoom Stereo Microscope

### Model YR269

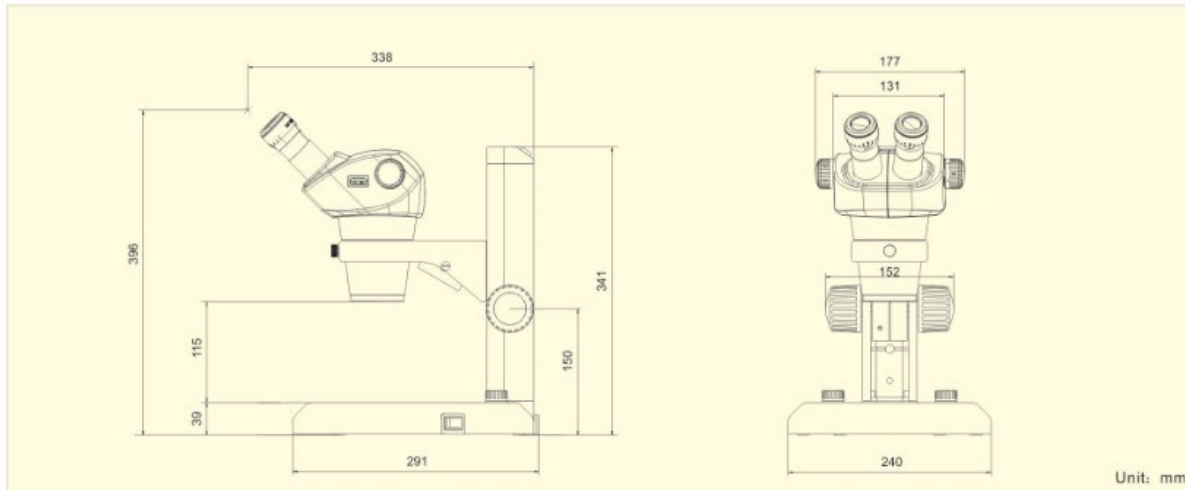

### Technical Specifications

Viewing Tube	Binocular viewing head, Inclined at 45°	●
Diopter Adjustment Eyepiece	Extra wide field eyepiece EW10X/Φ23	●
	WF15X/Φ16	○
	WF20X/Φ12	○
	WF30X/Φ9	○
Zoom Objective	0.6X-5X	●
Zoom Ratio	1: 8.3	●
Working Distance	115mm	●
Interpupillary Distance	55-75mm	●
Auxiliary objective	0.5X WD: 220mm	○
	0.7X WD: 125mm	○
	2X WD: 45mm	○
Stage Insert	Glass plate, Diameter 125mm	
	Glass plate, Diameter 100mm	●
	Opal & black acrylic plate, Diameter 125mm	
	Opal & black acrylic plate, Diameter 100mm	●
Focusing Range	105mm	●
Illumination	Incident Illumination 100V-240V/LED	●
	Transmitted Illumination 100V-240V/LED	●
Photo Attachment		○



#### #Let'sgivemore ♥

Thanks to your purchase, a donation will be made to a non-profit foundation that fights against breast cancer and helps most vulnerable communities.



All rights reserved © KALSTEIN France S. A. S.,  
Optimum Business Center 450 Rue Baden Powell,  
• 34000 Montpellier, France.  
Tél: +33 467158849 / +33 680760710/ +33 663810023  
<https://kalstein.eu>  
KALSTEIN FRANCE, S.A. S



## System Diagram

Model YR0269



	①	②	③	④	⑤	⑥
Length	279mm	279mm	12"	18"	280mm	330mm
Coaxial coarse & fine		√				



#Letsgivemore

Thanks to your purchase, a donation will be made to a non-profit foundation that fights against breast cancer and helps most vulnerable communities.



All rights reserved © KALSTEIN France S. A. S.,  
Optimum Business Center 450 Rue Baden Powell,  
• 34000 Montpellier, France.  
Tit: +33 467158849 / +33 680760710 / +33 663810023  
<https://kalstein.eu>  
KALSTEIN FRANCE, S.A. S



**Articles Kalstein**  
(Social Networks and Official Websites)

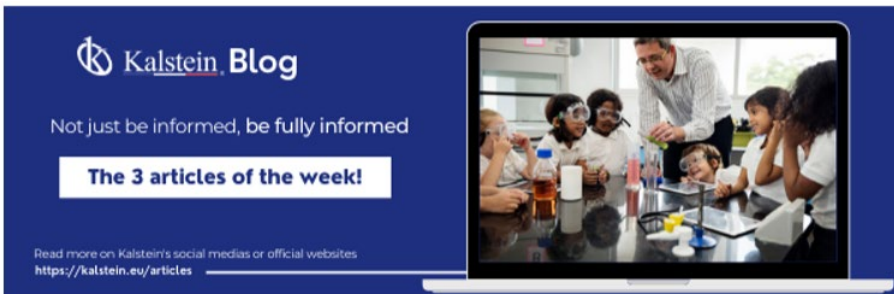

**Kalstein Blog**  
Not just be informed, be fully informed  
**The 3 articles of the week!**  
Read more on Kalstein's social medias or official websites  
<https://kalstein.eu/articles>



**1**  
Read this ARTICLE NOW  
**How does the climate affect your microscope?**  
A microscope is an instrument that allows observing and measuring objects that are too small to be seen with the naked eye. This is achieved through a complex system of lenses and mirrors, which form...

**Kalstein Blog**  
**Article of the week:**  
How does the climate affect your microscope?  
Read more on Kalstein's social medias or official websites  
<https://kalstein.eu/articles>



**2**  
Read this ARTICLE NOW  
**What is the importance of the laboratory refrigerator?**  
A refrigerator in a laboratory is one of the most important equipment. It is used to maintain, in a controlled environment (refrigerated space), various fluids and substances...

**Kalstein Blog**  
**Article of the week:**  
What is the importance of the laboratory refrigerator?  
Read more on Kalstein's social medias or official websites  
<https://kalstein.eu/articles>

**Kalstein Training Videos**  
(Youtube Channel and Official Websites)



Kalstein France - Jacinto Convit Foundation / Allianc...

23 views • 3 years ago

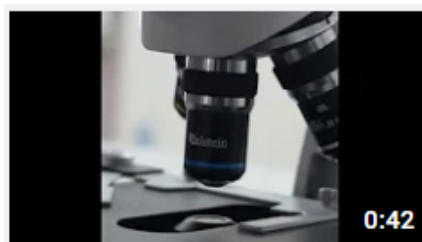

Kalstein's Microscopes

445 views • 1 week ago



MONTEPELLIER - FRANCE  
**SEDE**

Optimum Business Center,  
450 Rue Baden Powell,  
34000 Montpellier - France.

**Fax:** +33 (0) 4 67 15 88 49

**Tif:** +33 (0) 6 80 76 07 10

[sales@kalstein.eu](mailto:sales@kalstein.eu)

<https://kalstein.eu/>  
<https://www.kalstein.fr/>

**Official Websites for Latin America.**

