

**YR03385A and YR03385B-1**  
Design in Europe

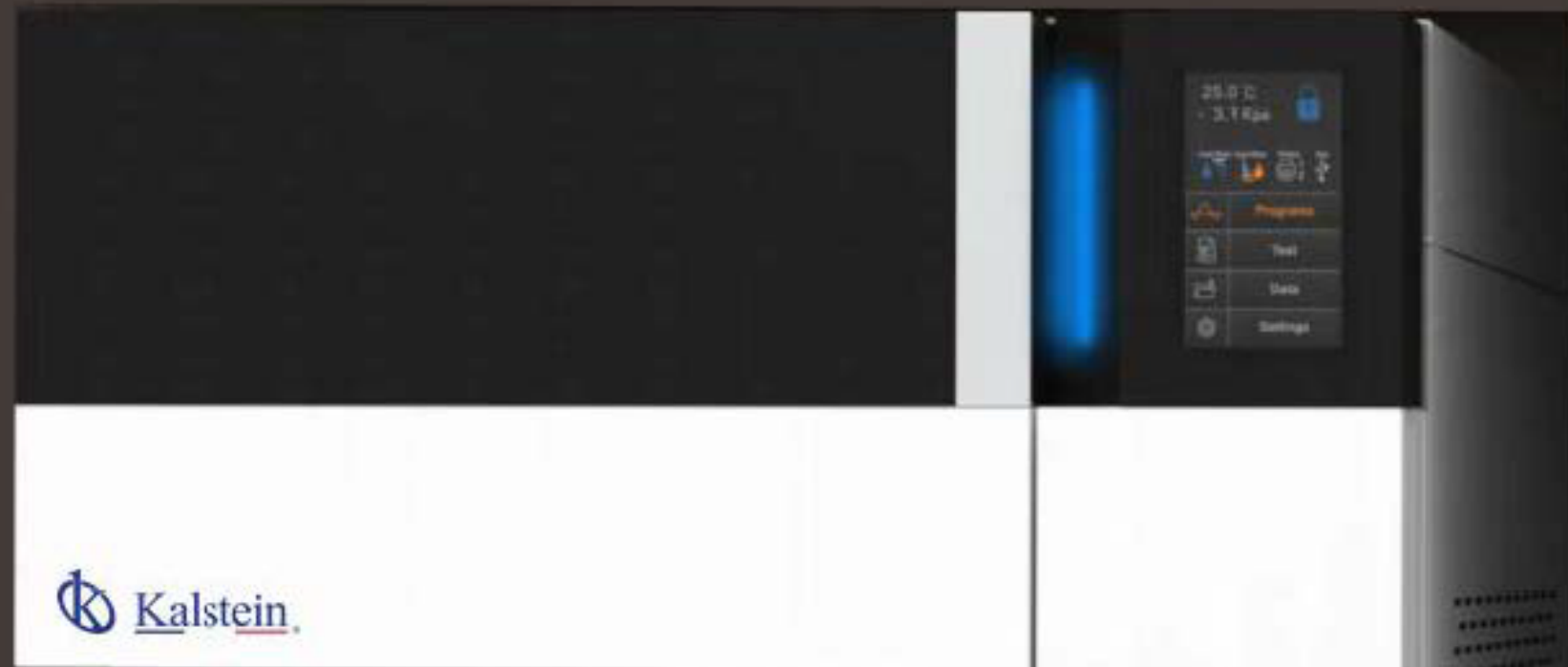

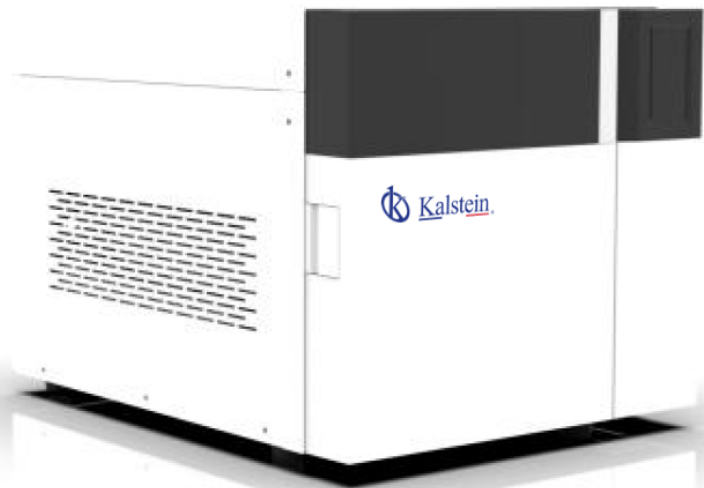

# Simple Full Touch

Information of function, operation process and sterilization status are well displayed for medical staff to operate the device by looking at the screen, which dramatically improves the customer experience.

The sterilization cycle can be selected quickly and directly from the program-related ICONS on the touch screen .





With the development of science and technology and the progress of the medical and health industry, the requirements of new medical staff on sterilizer are also increasingly high. The sterilizer of the future faces more top challenges, not only can meet the needs of safe and thorough sterilization, but also must have a more fashionable appearance, faster sterilization, more durable and better customer experience.

KALSTEIN YR03385A/ YR03385B-1 were born to meet these requirements.

Born from  
 **Kalstein**<sup>®</sup>

# Quick S cycle , 15 minutes

When a medical institution does not have many sterilizers but requires a lot of surgeries, or the instruments need to be sterilized urgently, it must need a sterilizer have a very quick cycle.

YR03385A/ YR03385B-1 specially presets a Quick S cycle for unwrapped instruments, and the fastest time (including drying) can reach 15 minutes.





# Sterilization cycle

PROGRAM	PROGRAM	STER. TIME	SUITABLE FOR		T218	T223
Quick S	134°C	4min	unwrapped solid instruments, unwrapped simple hollow instruments	Cycle Time* Drying Time* Load (Max)	13~20min 2min 2.4kg	15~25min 2min 3kg
Standard B	134°C	4min	Mixed load, Single wrapped solid instruments, Single hollow instruments	Cycle Time* Drying Time* Load (Max)	30~49min 15min 4.5kg	38~57min 15min 5kg
Soft B	121°C	20min	Mixed load, Single wrapped solid instruments, Single hollow instruments	Cycle Time* Drying Time* Load (Max)	38~54min 15min 4.5kg	46~62min 15min 5kg
Prion B	134°C	18min	Multiple wrapped instruments, Textiles, danger of infection instruments	Cycle Time* Drying Time* Load (Max) Load Textile(Max)	37~52min 15min 4.5kg 1.5kg	45~60min 15min 5kg 2kg

\* The cycle time is based on the load and with/without pre-heating.

\* Drying time can be adjusted.



BLUE	GREEN	RED
		
Switching on		
	Cycle process	
		Error

# Light Signature

Three colors make the operator to see clearly the working state of the sterilizer.

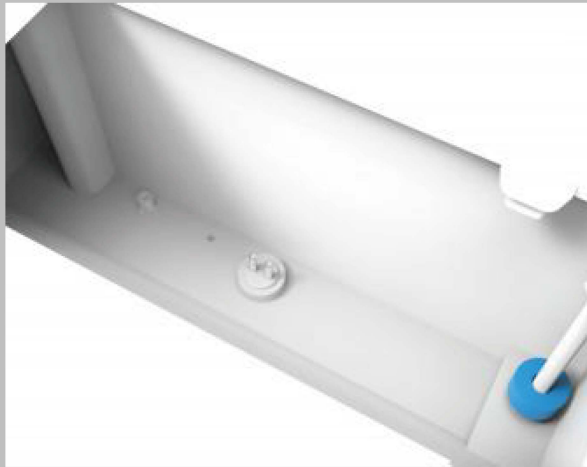

### Water quality sensor

The in-tank sensor checks the water quality any time to ensure long-lasting machine performance. And the value of water quality can be printed on the cycle report.



### Simplified water filling

Kalstein's YR03385A and YR03385B-1 are equipped with an automatic water filling system that sucks demineralized water from an external tank or a water demineraliser by the front quick couplings.



### Delay start

The delayed start function lets the user program sterilization and test cycle start times so it can be executed outside working hours.



## Report printing

The standard internal printers print the sterilization report automatically after a cycle finished. And also an optional barcode printer produces barcode labels containing all information relative to the sterilization cycle, making load traceability easier and faster.

## Data export

When the USB flash driver is plugged in, the cycle report will be automatically output to the USB flash driver after sterilization. The sterilizer also have internal memory which can store up to 9,999 cycles.



### Trays and Chamber

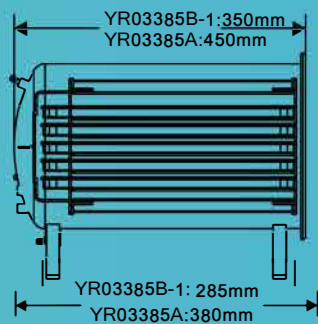
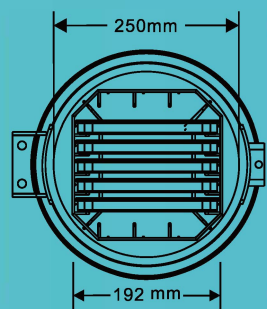

### Accessories

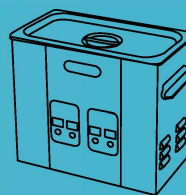

Ultrasonic Cleaner  
Order code:  
KalsteinAB

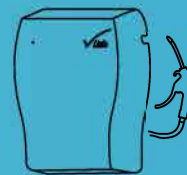

Water Deionizer  
Order code:  
KalsteinCB



Sealing Machine  
Order code:  
SEAL 20 20



Barcode Label Printer  
Order code:  
KalsteinLB

### Overall dimension

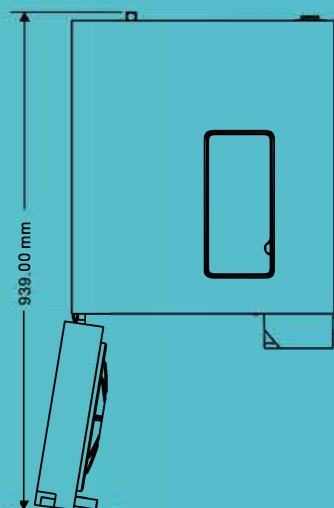
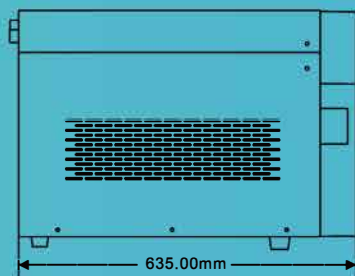
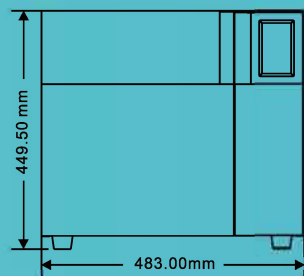



#LET'S GIVE  
MORE 



Tous les droits sont réservés © KALSTEIN France S. A. S.,  
Optimum Business Center 450 Rue Baden Powell,  
• 34000 Montpellier, France.  
Tél: +33 467158849 / +33 680760710/ +33 663810023  
<https://kalstein.eu>  
**KALSTEIN FRANCE, S. A. S**

