



LABORATORY LINES

INVERTED BIOLOGICAL
MICROSCOPE



Kalstein®

A different accompaniment, at your service

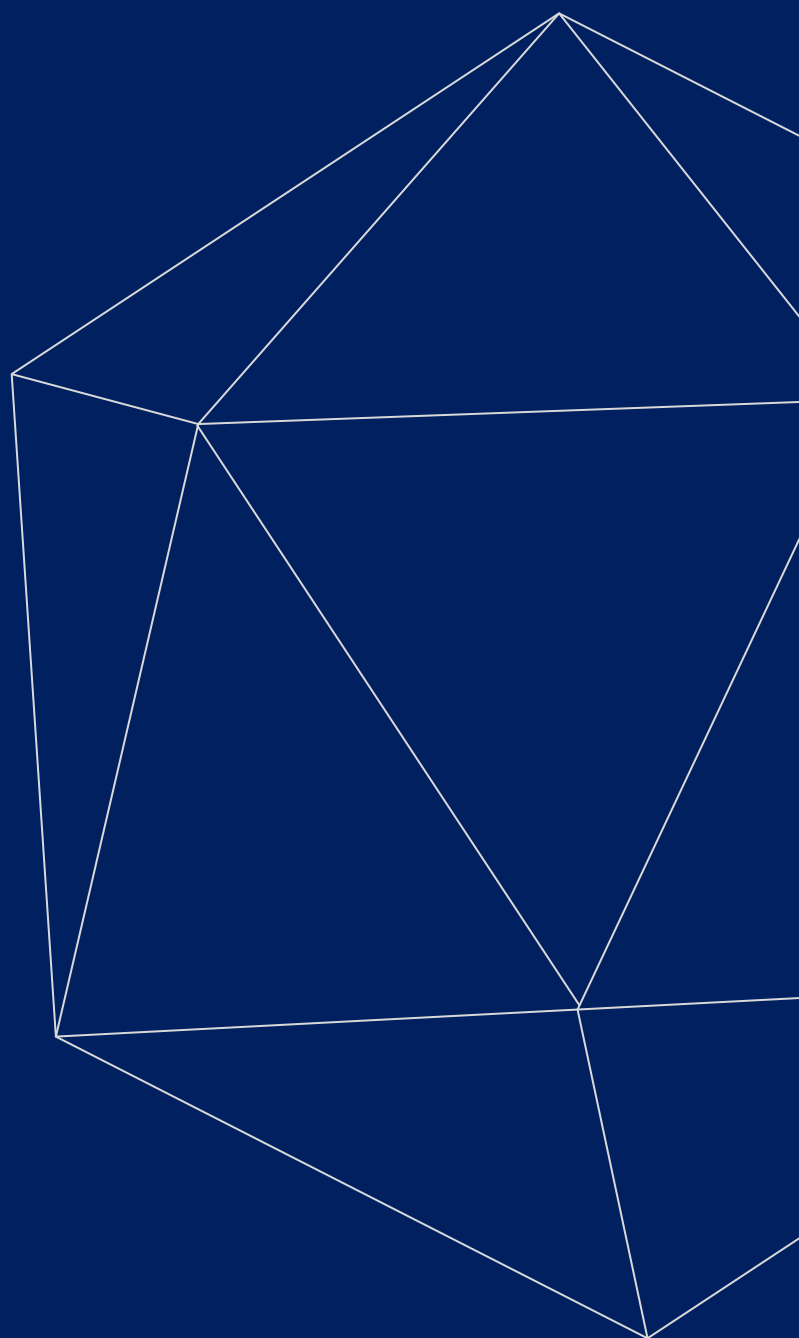



Kalstein®

A different accompaniment, at your service

OUR SERVICES

Benefits and Support

In Kalstein France, we take care of the full satisfaction of our customers, that is why we provide value-added services of the highest level based on our experience.



Online Inductions and Trainings

In any part of the world, receive your induction or training from our specialized team of engineers



Quick Response

Our work team is always available to response all your consults or questions, in order to support you in any situation.



#Letsgivemore ❤️

Thanks to your purchase, a donation will be made to a non-profit foundation that fights against breast cancer and helps most vulnerable communities.



Technical Support

Enjoy of personalized advice for the correct preventive and corrective maintenance of your equipment, thanks to Kalstein's manuals and articles, special catalogues and video tutorials.



Delivery Logistics

We take care of all the necessary logistics for the dispatch of your goods, whether is by sea, land or air.



Kalstein Worldwide

With more than 25 years growing with our customers, Kalstein's multiformat and modern content, is now present in more than 10 countries and increasing.



KALSTEIN® Microscope Inverted Microscope, Transmit Light YR02603(A)



Long Working Distance
Working Distance 72mm (With Condenser),
195mm (Without Condenser)



Working Stage
Mechanical Stage Size 210x241mm, Round
Slide Size Φ 110mm
Culture Dish Holder 54mm



#Letsgivingore

Thanks to your purchase, a donation will be made to a non-profit foundation that fights against breast cancer and helps most vulnerable communities.



All rights reserved © KALSTEIN France S. A. S.,
2 Rue Jean Lantier • 75001 Paris •
+33 1 78 95 87 89 / +33 6 80 76 07 10 •
<https://kalstein.eu>
KALSTEIN FRANCE, S. A. S



Product Details



Head & Eyepiece

Seidentopf Trinocular Head Inclined 45° Interpupillary Distance 48~76mm, Light Split Switch
E100:P0 / E20:P80
WF10x/22mm, Dia.30mm, High Eyepoint, Diopter Adjustable



Condenser & Light Source With Filters: Blue, Dia.34mm; Green, Dia.34mm
Koehler Illumination Halogen 6V/30W For YR02603(A)
Koehler Illumination 5W LED For YR02603(A)-TR



#Letsgivemore

Thanks to your purchase, a donation will be made to a non-profit foundation that fights against breast cancer and helps most vulnerable communities.



All rights reserved © KALSTEIN France S. A. S.,
2 Rue Jean Lantier • 75001 Paris •
+33 1 78 95 87 89 / +33 6 80 76 07 10 •
<https://kalstein.eu>
KALSTEIN FRANCE, S. A. S



INVERTED BIOLOGICAL MICROSCOPE



Objectives
LWD Infinity Plan Fluorescent
Objectives 10x, 20x, 40x
LWD Infinity Plan Phase Contrast
Fluorescent Objectives 20x



**3W LED Koehler Illumination, Field
Diaphragm**
Powered By Safety Low Voltage Charger
Input Wide Voltage 100V-240V, Output
5V1A, Support Power Bank Supply For
Outdoor Use



**10x Objective
Observation Effect**

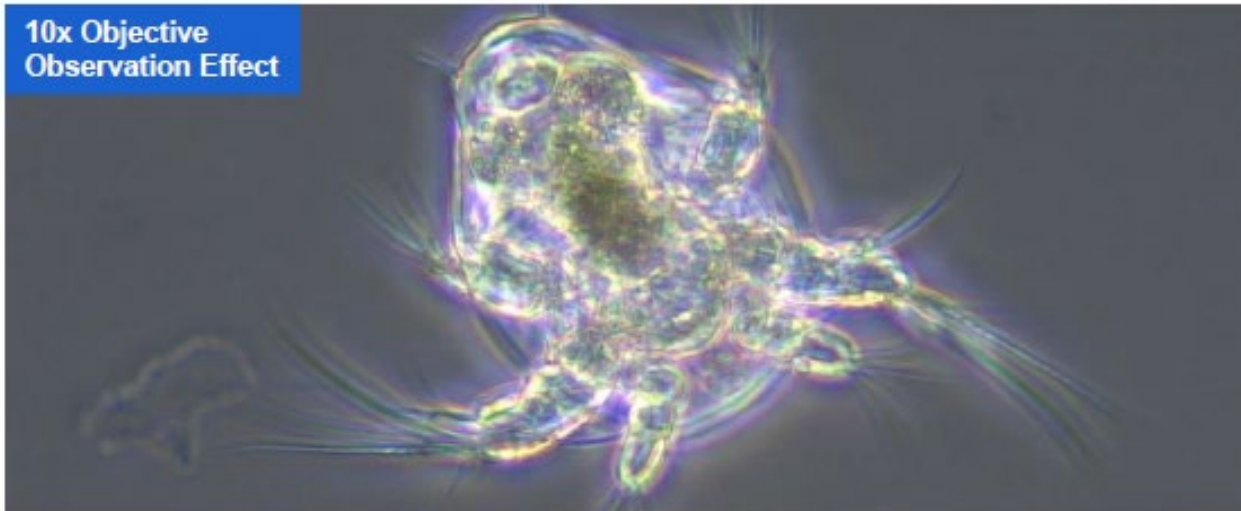

#Letsgivemore ♥

Thanks to your purchase, a donation will be made to a non-profit foundation that fights against breast cancer and helps most vulnerable communities.



All rights reserved © KALSTEIN France S. A. S.,
2 Rue Jean Lantier • 75001 Paris •
+33 1 78 95 87 89 / +33 6 80 76 07 10 •
<https://kalstein.eu>
KALSTEIN FRANCE, S. A. S



Product Specification



Items	YR02603(A) nverted Biological Microscope	YR02603(A)	YR02603(A)-TR	Cata. No.
Head	Seidentopf Trinocular Head Inclined 45°, Interpupillary Distance 48~76mm, Light Split Switch E100:P0 / E20:P80	•	•	A53.2643
Eyepiece	WF10x/22mm, Dia.30mm, High Eyepoint,, Diopter Adjustable	••	••	A51.2621-1022
	WF15X/16mm, Dia.30mm, High Eyepoint, Diopter Adjustable	••	••	A51.2621-1516
	WF20X/12mm, Dia.30mm, High Eyepoint, Diopter Adjustable	••	••	A51.2621-2012
Nosepiece	Quintuple	•	•	A54.2610-N925
LWD Infinity Plan Semi-APO Objectives Newly Update 2021	L Plan FL 4x/0.11 W.D.=12.1mm	○	○	A5F.2635-4
	L Plan FL 10x/0.25 W.D.=10.3mm	•	•	A5F.2635-10
	L Plan FL 20x/0.45 W.D.=5.8mm	•	•	A5F.2635-20
	L Plan FL 40x/0.65 W.D.=5.1mm	•	•	A5F.2635-40
LWD Infinity Plan Phase Contrast Semi-APO Objectives Newly Update 2021	L Plan FL PHP 4x/0.10 W.D.=9.2mm	○	○	A5C.2635-4
	L Plan FL PHP 10x/0.25 W.D.=10.3mm	○	○	A5C.2635-10
	L Plan FL PHP 20x/0.45 W.D.=5.8mm	•	•	A5C.2635-20
	L Plan FL PHP 40x/0.65 W.D.=5.1mm	○	○	A5C.2635-40
Phase Contrast	Centering Telescope 11x	○	○	A5C.2610
	Annular Spot 4x	○	○	A5C.2611-4
	Annular Spot 20x/ 40x	•	•	A5C.2611-10
	Annular Spot 10x	•	•	A5C.2611-20/40
Working Stage	Mechanical Stage Size 210x241mm, Round Slide Size Φ110mm	•	•	A54.2601-D4
	Attachable Mechanical Stage For 96 Holes Plate Moving Range 128x80mm	○	○	A54.2605
	Culture Dish Holder 65mm	○	○	A54.2606-65
	Culture Dish Holder 54mm	•	•	A54.2606-54
	Culture Dish Holder 35mm	○	○	A54.2606-35
	Holder For Blood Cell Counter	○	○	A54.2606-BC
	Universal Holder (New Accessory 2021)	○	○	A54.2606-UH
Round Glass Holder (New Accessory 2021)	○	○	A54.2606-GL	
Condenser	Long Working Distance, Quickly Detachable, N.A.0.3, Working Distance 72mm (With Condenser), 195mm (Without Condenser).	•	•	A56.2614-D4
Tranmist Illumination	Koehler Illumination Halogen 6V/30W, Input Voltage 100V~240V	•	○	A56.2613-6V30W
	Koehler Illumination 5W LED, Powered By Safety Low Voltage Charger, Input Wide Voltage 100V-240V, Output 5V1A, Support Power Bank Supply For Outdoor Use	○	•	A56.2651-5W
Reflect Illumination	Koehler Illumination 5W LED, Powered By Safety Low Voltage Charger, Input Wide Voltage 100V-240V, Output 5V1A, Support Power Bank Supply For Outdoor Use	-	•	
	Polarizing Set		•	
Power	ECO, Auto Power Off System. Power Off Automatically Upon User Leaving 10 Minutes, Power On Automatically Upon User Approaching Detected, This Function Can Be Shut Down Manually	○	○	A56.2660



#Letsgivemore

Thanks to your purchase, a donation will be made to a non-profit foundation that fights against breast cancer and helps most vulnerable communities.



All rights reserved © KALSTEIN France S. A. S.,
2 Rue Jean Lantier • 75001 Paris •
+33 1 78 95 87 89 / +33 6 80 76 07 10 •
<https://kalstein.eu>
KALSTEIN FRANCE, S. A. S





Filter	Blue, Dia.34mm	•	•	A56.2616-34B
	Green, Dia.34mm	•	•	A56.2616-34G
	Amber, Dia.34mm	○	○	A56.2616-34A
	Grey, Dia.34mm	○	○	A56.2616-34N
Adapter	C-Mount 0.5x, Focus Adjustable	○	○	A55.2601-05
	C-Mount 0.75x, Focus Adjustable	○	○	A55.2601-75
	C-Mount1.0x, Focus Adjustable	○	○	A55.2601-10
Epi Fluorescence Illumination	Upgrade to A16.2614-2 Inverted Fluorescence Microscope With: B,G China Fluorescent Filter 3 Holes Fluorescent Slide Unit, With Field Diaphragm, Center Adjustable 100W Mercury Lamp House 100W Mercury Power Box, Digital Disp. Ultraviolet Protection Barrier	○	○	A5F.2603-2
	Upgrade to A16.2614-4 Inverted Fluorescence Microscope With: B,G,U,UV China Fluorescent Filter 3 Holes Fluorescent Slide Unit, With Field Diaphragm, Center Adjustable 100W Mercury Lamp House 100W Mercury Power Box, Digital Disp. Ultraviolet Protection Barrier	○	○	A5F.2603-4
	Upgrade to A16.2614-L2 Inverted Fluorescence Microscope With: B,G China Fluorescent Filter 3 Holes Fluorescent Slide Unit, With Field Diaphragm, Center Adjustable 5W LED Lamp House 5W LED Power Box Ultraviolet Protection Barrier	○	○	A5F.2604-2
	Upgrade to A16.2614-L4 Inverted Fluorescence Microscope With: B,G,U,UV China Fluorescent Filter 3 Holes Fluorescent Slide Unit, With Field Diaphragm, Center Adjustable 5W LED Lamp House 5W LED Power Box Ultraviolet Protection Barrier	○	○	A5F.2604-4
Package	Packing Size: 660mmx590mmx325mm			
Weight	Gross Weight: 18 kgs, Net Weight: 13.5 kgs			
Note: "•"In Table Is Standard outfits, "○" Is Optional Accessories.				

Product Accessories



A51.2621-1022
WF10x/22mm



A51.2621-1516
WF15x/16mm



A51.2621-2012
WF20x/12mm



A56.2660
ECO, Auto
Power Off System



#Letsgivingmore ♥

Thanks to your purchase, a donation will be made to a non-profit foundation that fights against breast cancer and helps most vulnerable communities.



All rights reserved © KALSTEIN France S. A. S.,
2 Rue Jean Lantier • 75001 Paris •
+33 1 78 95 87 89 / +33 6 80 76 07 10 •
<https://kalstein.eu>
KALSTEIN FRANCE, S. A. S.





A52.2609 LWD Infinity Plan Objective: 10x, 20x, 40x
A5C.2630 LWD Infinity Plan Phase Contrast Objective: 20x



A55.2601-10
C-Mount 1.0x,
Focus Adjustable



A5C.2610 Centering Telescope 11x (Optional)
& A5C.2611 Annular Spot 10x/20x/40x



A55.2601-75
C-Mount 0.75x,
Focus Adjustable



A54.2601-D4
Mechanical Stage
Size 210x241mm
Round Slide Size
Φ110mm



A55.2601-05
C-Mount 0.5x,
Focus Adjustable



A54.2606-65 & A54.2606-35
Culture Dish Holder 65mm & Culture
Dish Holder 35mm (Optional)

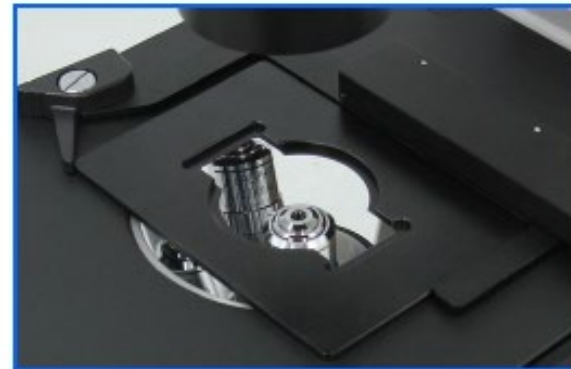

A54.2606-54
Culture Dish Holder 54mm



#Letsgivemore ♥

Thanks to your purchase, a donation will be made to a non-profit foundation that fights against breast cancer and helps most vulnerable communities.



All rights reserved © KALSTEIN France S. A. S.,
 2 Rue Jean Lantier • 75001 Paris •
 +33 1 78 95 87 89 / +33 6 80 76 07 10 •
<https://kalstein.eu>
KALSTEIN FRANCE, S. A. S.





A56.2614-D4
Long Working Distance
Quickly Detachable
N.A.0.3 Condenser



A56.2616
Filter: Blue, Green;
Amber; Grey
(Optional)

Product Size(mm)

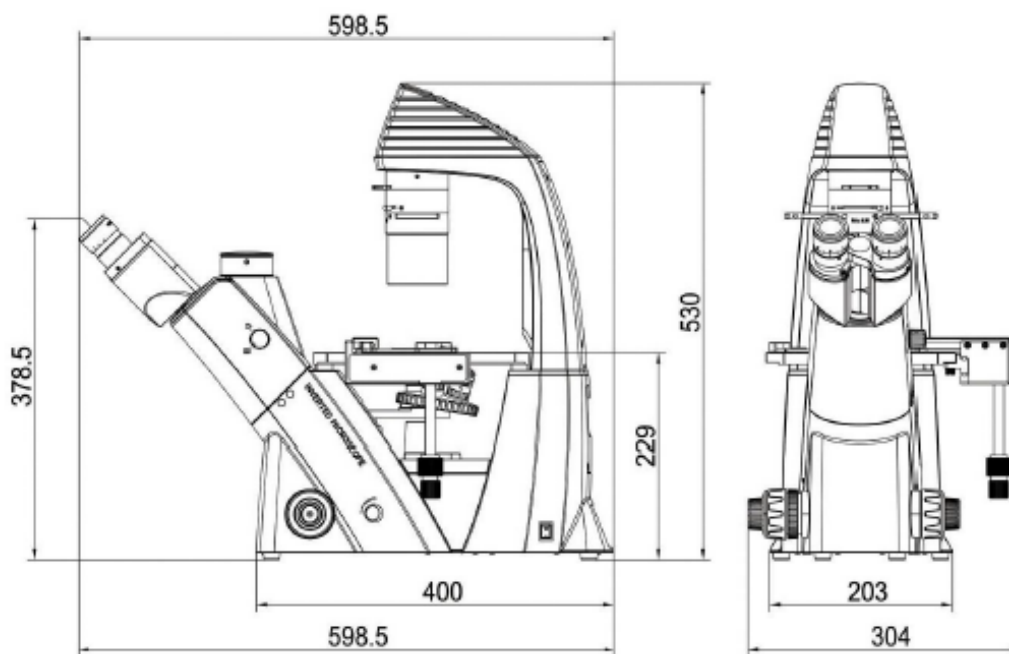

#Letsgivemore ♥

Thanks to your purchase, a donation will be made to a non-profit foundation that fights against breast cancer and helps most vulnerable communities.



All rights reserved © KALSTEIN France S. A. S.,
2 Rue Jean Lantier • 75001 Paris •
+33 1 78 95 87 89 / +33 6 80 76 07 10 •
<https://kalstein.eu>
KALSTEIN FRANCE, S. A. S



General Layout Diagram

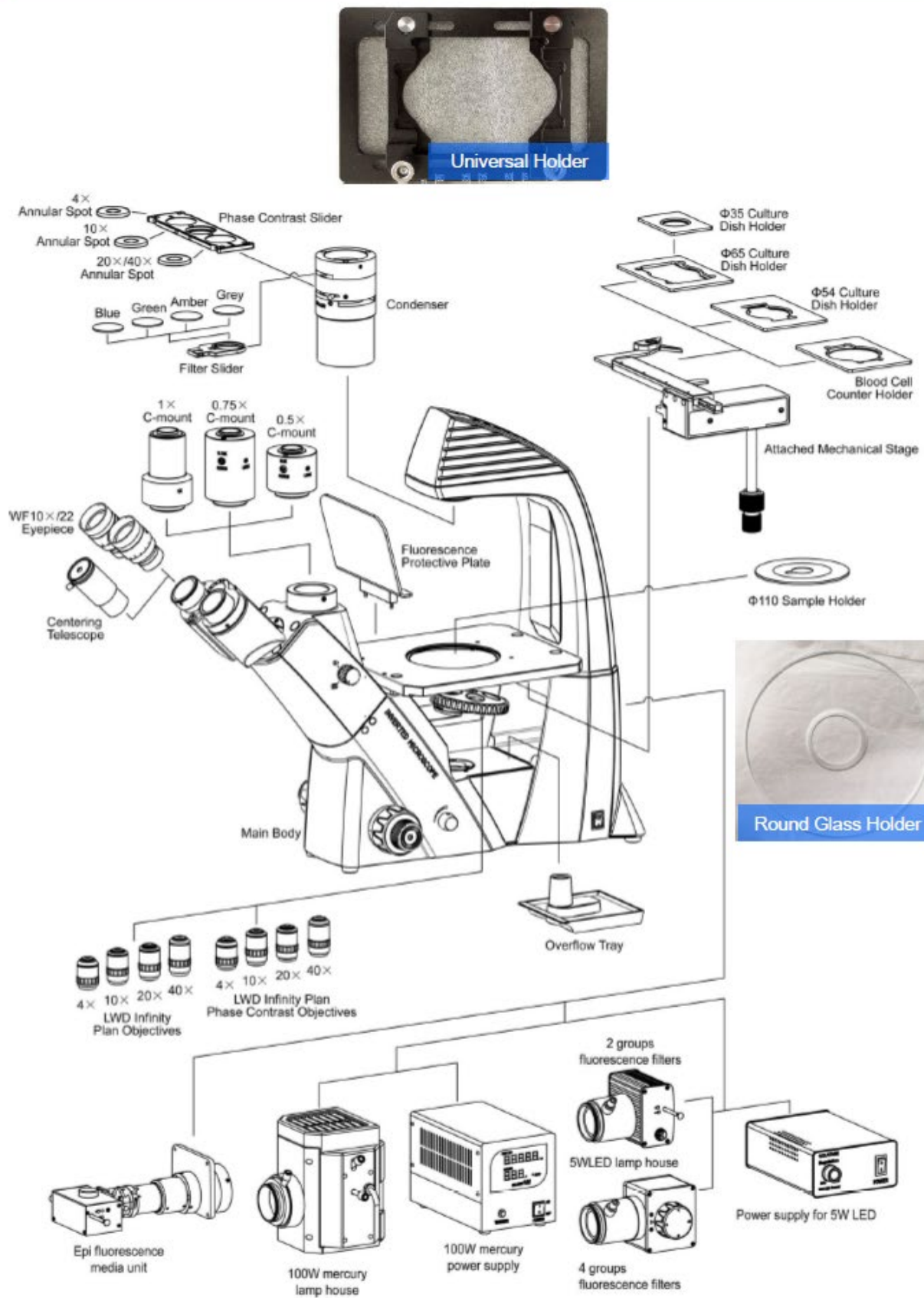

#Letsgivemore

Thanks to your purchase, a donation will be made to a non-profit foundation that fights against breast cancer and helps most vulnerable communities.



All rights reserved © KALSTEIN France S. A. S.,
 2 Rue Jean Lantier • 75001 Paris •
 +33 1 78 95 87 89 / +33 6 80 76 07 10 •
<https://kalstein.eu>
 KALSTEIN FRANCE, S. A. S





 **Kalstein**[®]
A different accompaniment, at your service

#LETSGIVEMORE 

**WITH THE
ACQUISITION
OF A KALSTEIN
EQUIPMENT**

YOU MAKE A CONTRIBUTION TO:



**Fundación
Jacinto Convit**

<https://www.jacintoconvit.org/>



<https://onetreepanted.org>



Humatem

Solidarité et coopération
biomédicale

<https://www.humatem.org/>



**MANIAPURE
FOUNDATION USA**

<https://www.maniapurefoundation.org/>

Articles Kalstein
(Social Networks and Official Websites)

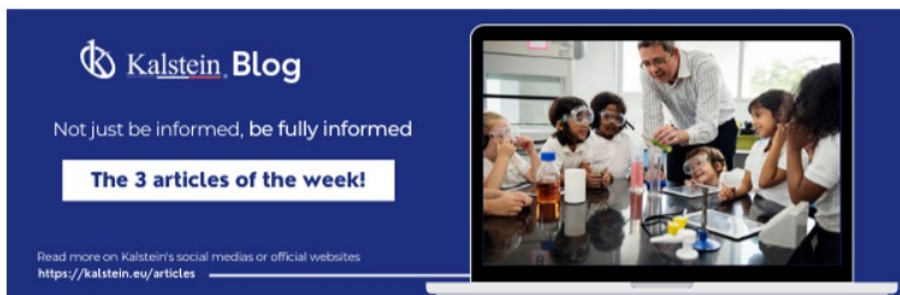

Kalstein Blog
Not just be informed, be fully informed
The 3 articles of the week!
Read more on Kalstein's social medias or official websites
<https://kalstein.eu/articles>



1
Read this ARTICLE NOW
How does the climate affect your microscope?
A microscope is an instrument that allows observing and measuring objects at a very small scale. This is achieved through a complex system of lenses and mirrors, which form...

Kalstein Blog
Article of the week:
How does the climate affect your microscope?
Read more on Kalstein's social medias or official websites
<https://kalstein.eu/articles>



2
Read this ARTICLE NOW
What is the importance of the laboratory refrigerator?
A refrigerator is a device that is one of the most common pieces of equipment used in laboratories. It is a controlled environment (refrigerated space), various fluids and substances...

Kalstein Blog
Article of the week:
What is the importance of the laboratory refrigerator?
Read more on Kalstein's social medias or official websites
<https://kalstein.eu/articles>

Kalstein Training Videos
(Youtube Channel and Official Websites)



Kalstein France - Jacinto Convit Foundation / Alliances
23 views • 3 years ago

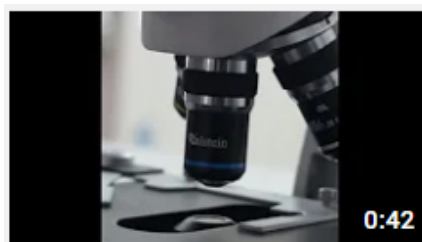

Kalstein's Microscopes
445 views • 1 week ago



PARIS - FRANCE
HEADQUARTER
2 Rue Jean Lantier
75001 Paris - France

Tlf: +33 (0) 01 78 95 87 89
Cel: +33 (0) 6 80 76 07 10
sales@kalstein.eu

<https://kalstein.eu/>
<https://www.kalstein.fr/>

